

# ST. MARY Catholic Secondary School

## 2020/2021 PRE-REQUISITE FLOW CHART

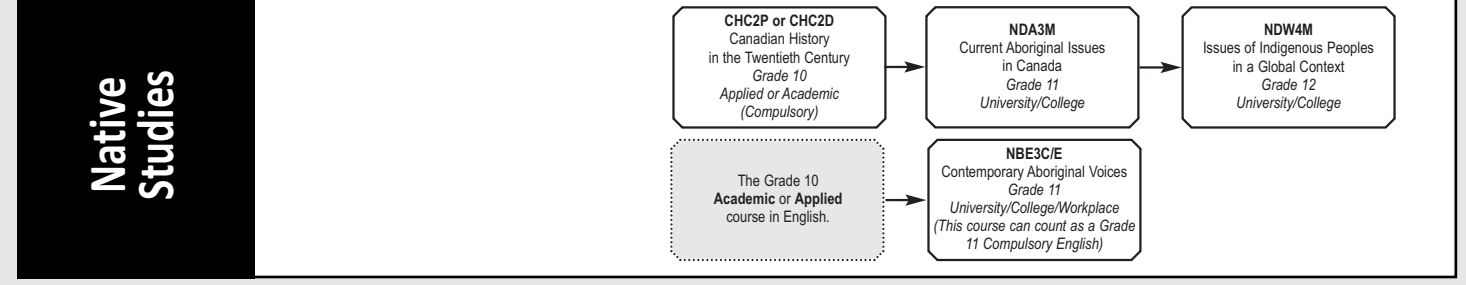

1050 Birchwood Trail, Cobourg, ON K9A 5S9  
 Phone: 905-372-4339 | Fax: 905-373-4529 | Web: www.smcss.ca  
 SOCIAL MEDIA LINKS  
 Facebook: www.facebook.com/smcss.ca | Twitter: @SMCSSThunder  
 ACADEMIC CALENDAR COURSE DESCRIPTIONS  
 MyBlueprint : www.smcss.ca/en/students/myblueprint.asp

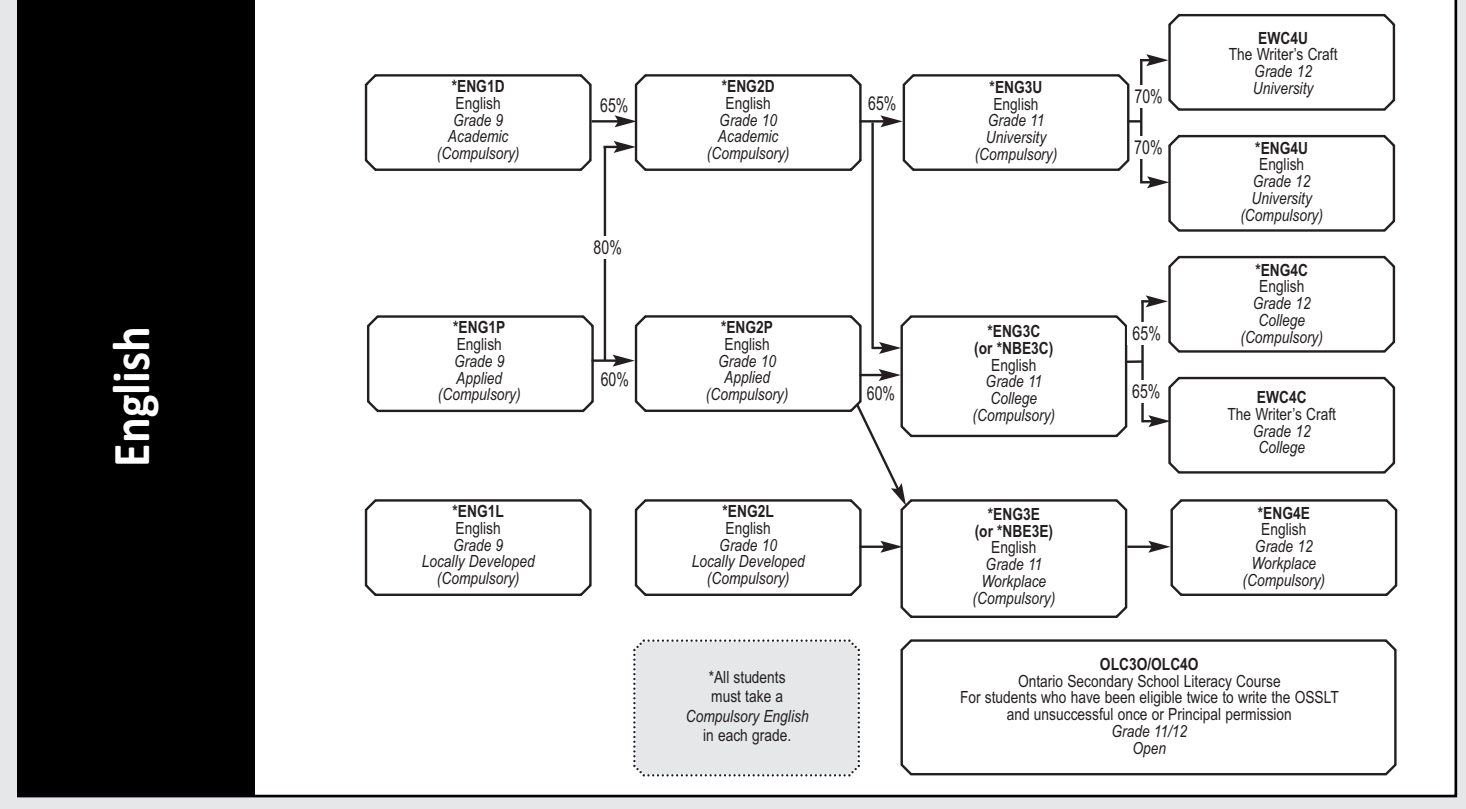
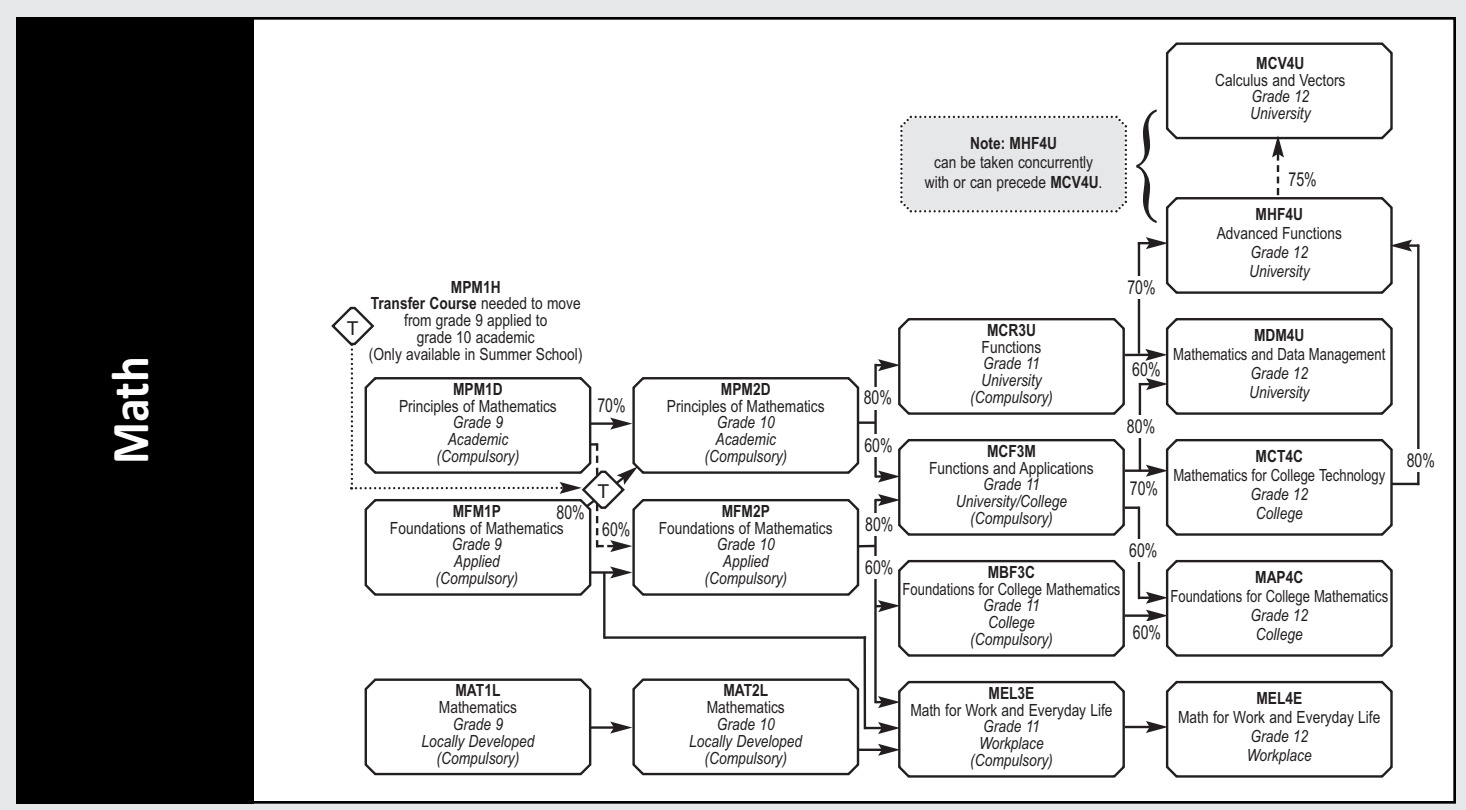

COURSE CALENDAR MY BLUEPRINT LINK: [www.smcss.ca/en/students/myblueprint.asp](http://www.smcss.ca/en/students/myblueprint.asp)

Please note that where enrollment is insufficient, a course may be cancelled.

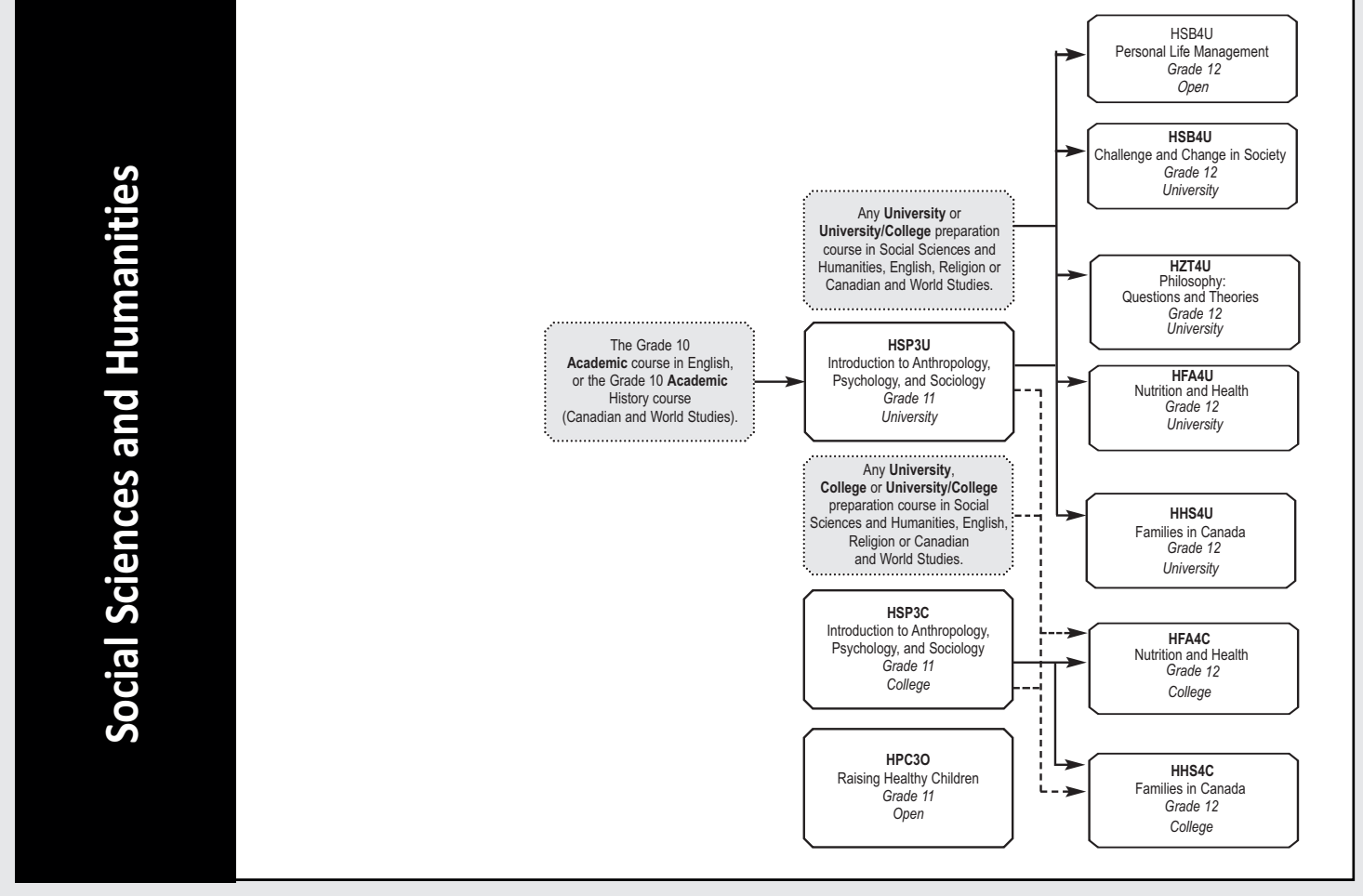
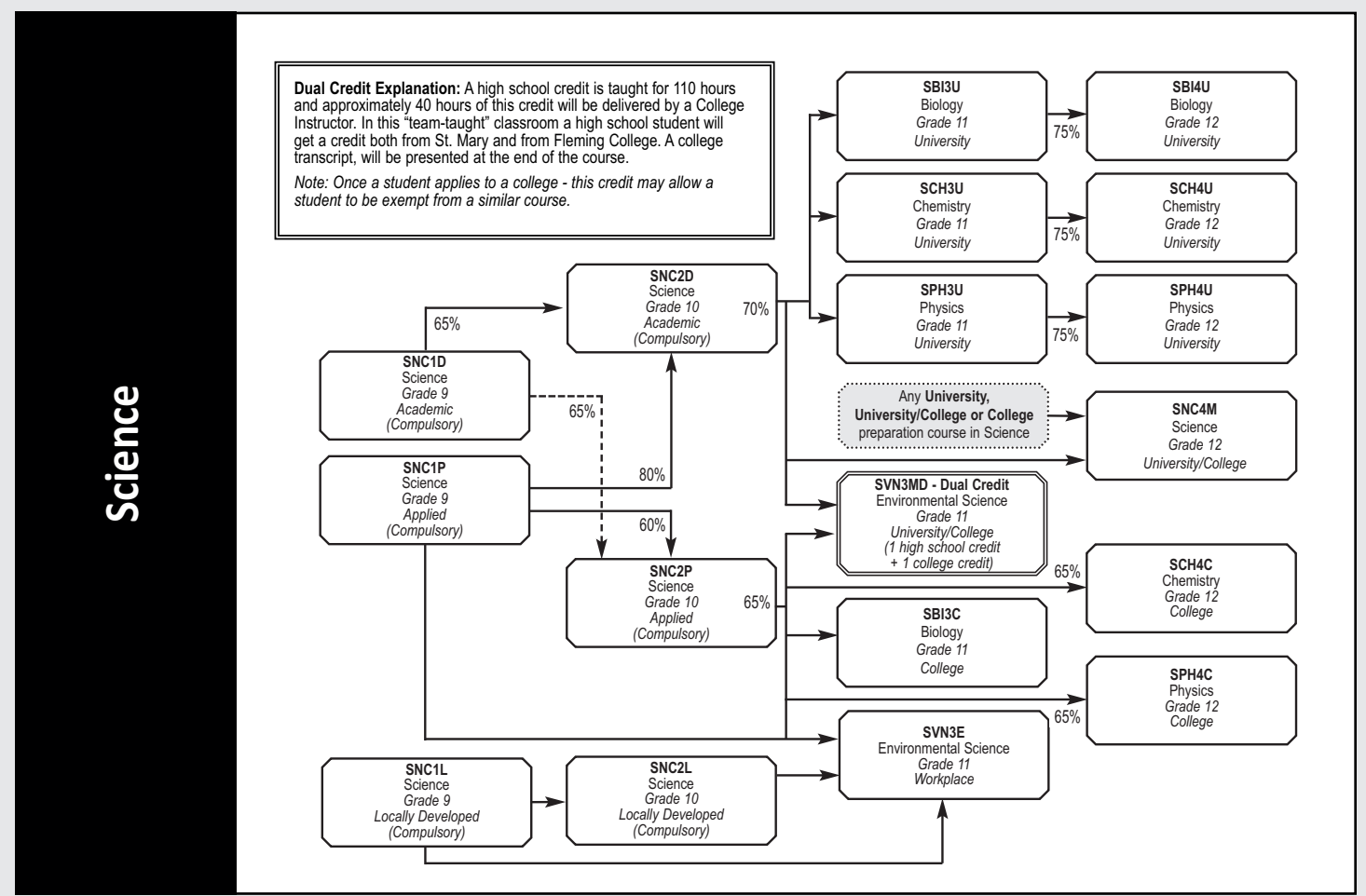
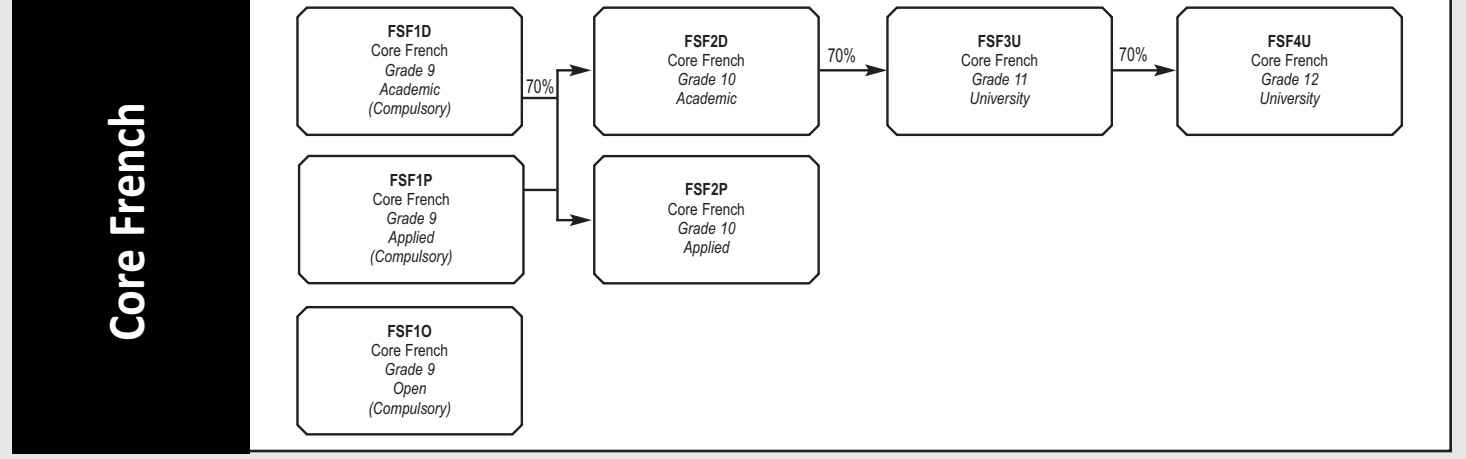
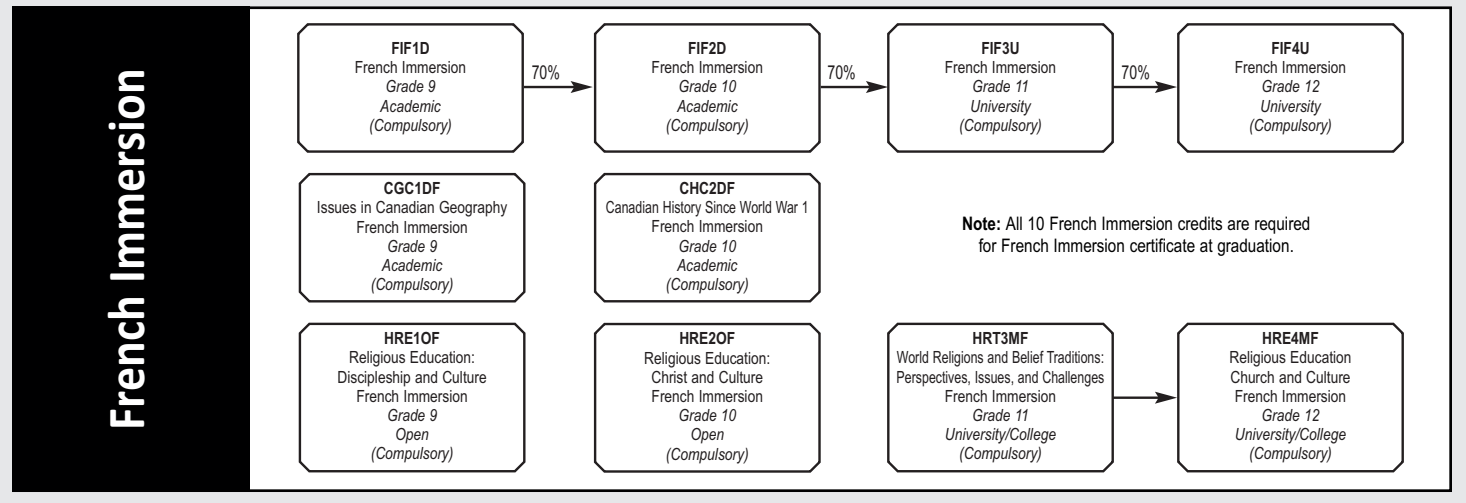

COURSE CALENDAR MY BLUEPRINT LINK: [www.smcss.ca/en/students/myblueprint.asp](http://www.smcss.ca/en/students/myblueprint.asp)

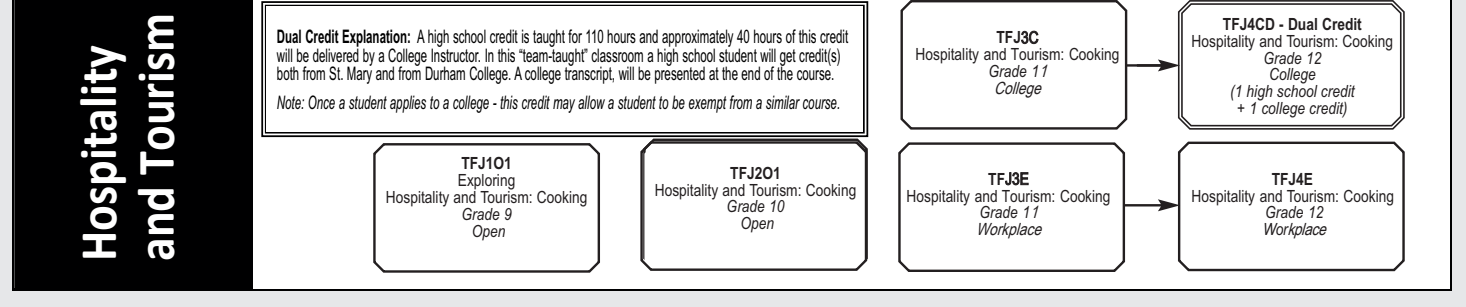
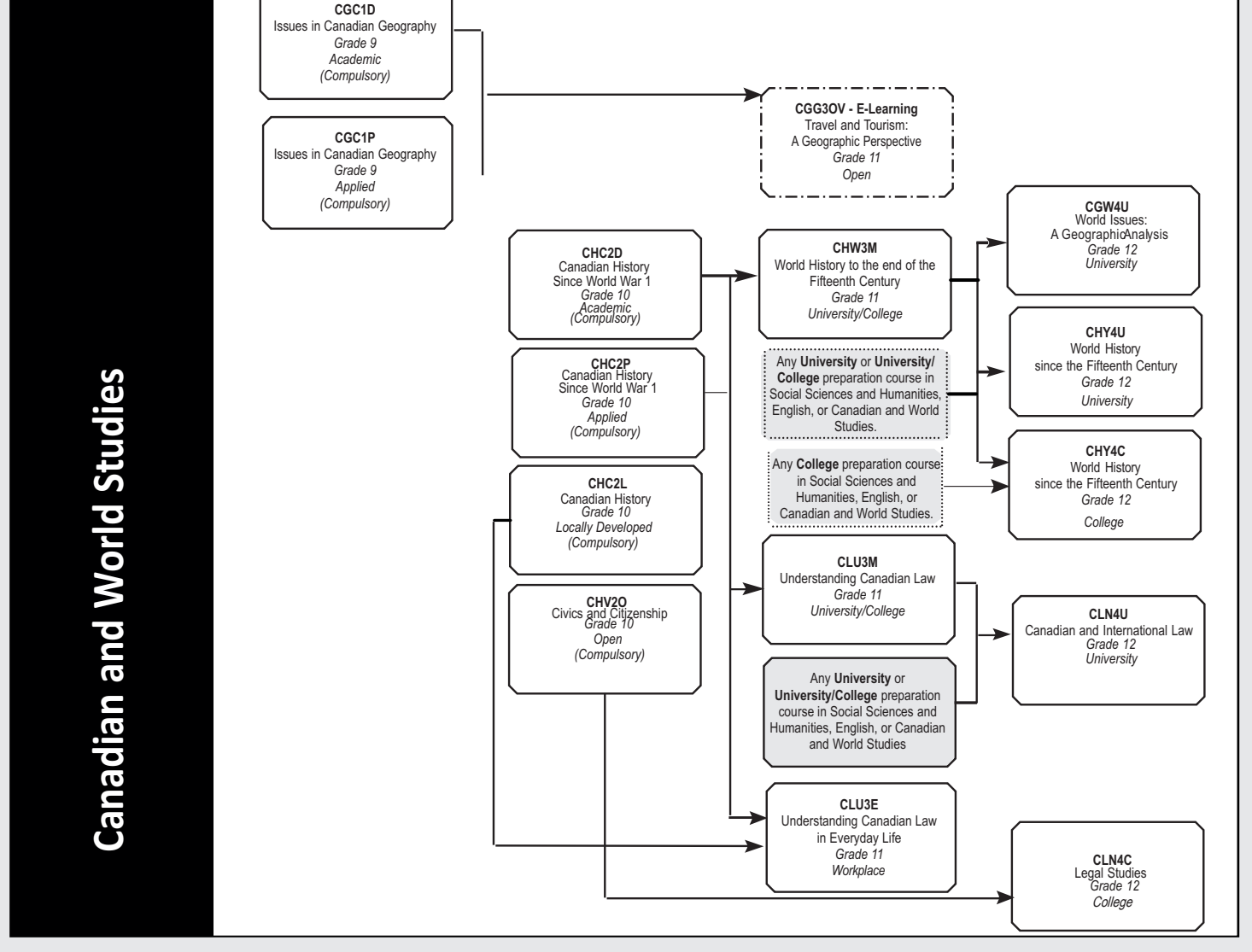
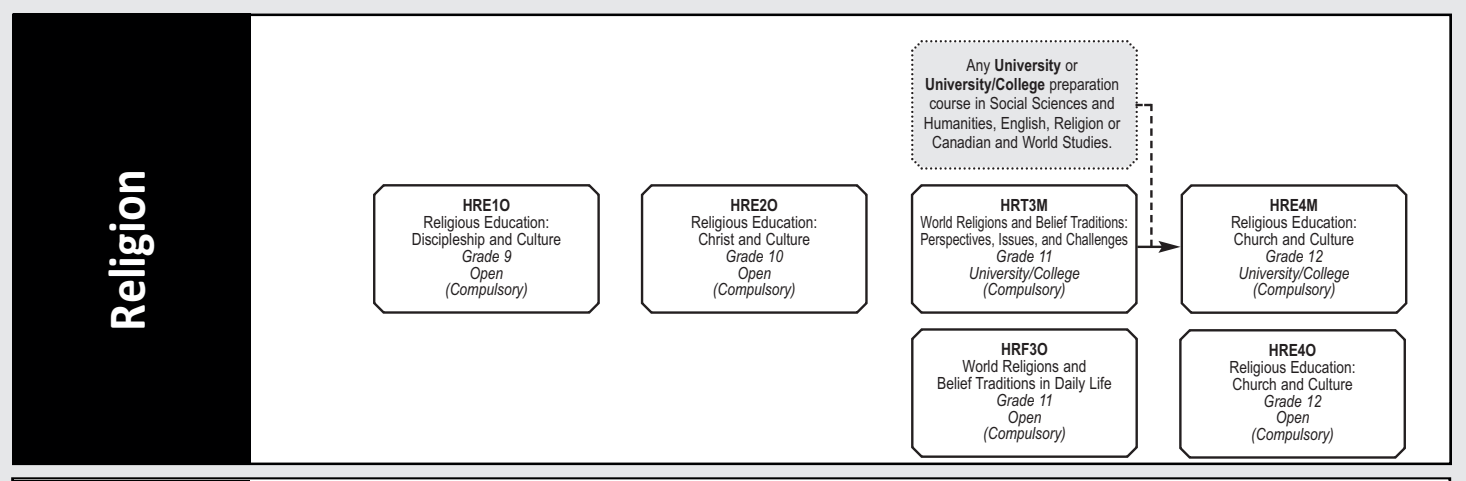

COURSE CALENDAR MY BLUEPRINT LINK: [www.smcss.ca/en/students/myblueprint.asp](http://www.smcss.ca/en/students/myblueprint.asp)

